

RISING锐鑫 | 汉中市锐鑫刃具有限公司
Hanzhong RUIXIN Precision Tools Co.,LTD



生产部：陕西省汉中市西乡县柳树镇
办公地址：陕西省汉中市汉台区民主街汉宇领峰1号楼708室
客服电话：400 0916 630
电话：+86-916-2513361
传真：+86-916-2258996
公司名称：汉中市锐鑫刃具有限公司
开户银行：工商银行汉中西大街支行
银行账号：2606021709200017716
税号：610724094019705
联系人：任秀军
邮编：723000
邮箱：admin@rxjmtool.com ruixinjmrjhz@126.com
网址：www.rxjmtool.com

Manufacturing Department:Liushutown,Xixiang,Hanzhong,Shaanxi Province.China
Office address:7/F,HanYuLingFeng-1,West Street,Hantai District, Hanzhong, City Shaanxi Province.China
CSH Tel: 400 0916 630
Tel:+86-916-2513361
Fax:+86-916-2258996
Company Name:Hanzhong RUIXIN Precision Tools Co.,LTD
Opening Bank : Industrial and Commercial Bank of China Hanzhong City West Street Branch
Account No: 2606021709200017716
Tax No: 610724094019705
Liaison:Ren Xiu Jun
Post code:723000
E-mail:admin@rxjmtool.com ruixinjmrjhz@126.com
Web: www.rxjmtool.com



RISING锐鑫

汉中市锐鑫刃具有限公司
HANZHONG RUIXIN PRECISION TOOLS CO.,LTD



官方网站 Official Website



官方微信 Official Micro Letter

企业简介

汉中市锐鑫刃具有限公司引进数控机床，采用先进生产工艺，专业研发生产口腔旋转刀具。

主要生产：CNC钨钢磨头、钨钢车针(FG、HP、RA)、金刚砂车针(FG、HP)、烧结金刚石磨头、齿科硅橡胶磨头、陶瓷磨头、骨、首饰、玉石雕刻磨头、美容科、骨科、矫形外科磨头、异型磨头等。

我们本着：锐意进取，不断创新，高效务实的经营理念。诚实守信，服务优先。以提供规格齐全，品质优良，价格合理的牙科旋转刀具而不懈努力！

我们诚挚的希望同国内外朋友建立长期友好合作关系，共同开拓，共创辉煌！

Brief Introduction

Hanzhong RuiXin Precision Tools Co.,LTD adopts advanced manufacturing technique,imports numerical control machine, develops and produces dental helix tools.

The main products are tungsten steel burs, diamond burs (FG,HP,RA), silicon carbide burs(FG,HP), sintered diamond burs, ceramics burs, dental silicon rubber burs, stone and boulder carving burs, cosmetology, orthopaedics, mechanic burs of abnormal shape etc..

We always persist in being eager to progress, making steady progress, being pragmatic,efficient,honest,faithful,and services preference.

We make great efforts to provide helix tools with complete specifications,excellent qualities and reasonable prices.

We sincerely hope to construct long-term friendly cooperation with the friends at home and abroad, exploit and develop together.

目录/CONTENT



P01-05
FG/RA钨钢车针
FG/RA Carbide Burs



P01-05
FG/RA弯机头低速钨钢车针
FG/RA Carbide Burs



P06-07
HP低速直柄钨钢车针
HP Carbide Burs



P08-14
HP CNC钨钢磨头
HP CNC Carbide Burs



P15-23
FG/RA 金刚砂车针
FG/RA Diamond Burs



P24-27
电镀金钢砂磨头 砂片
Electroplated HP diamonds Drscs



P28-29
HP烧结金刚石磨头
HP Sinter Diamond Burs



P30-34
牙科门诊用硅橡胶抛光磨头
Silicon rubber polishing bur
applied in Dentist Clinic



P35
HP带柄车石
Mounted Points



骨科球钻
Orthopaedic ball drill

FG.RA标准说明 Standard Description

ISO NO
500=钨钢 (硬质合金) Carbide

● 柄部直径示意图

	ISO	直径
FGSS	313	1.6mm
FG	314	1.6mm
FG L	315	1.6mm
FG XL Surg 手术车针	316	1.6mm
RA	204	2.35mm
RAL SURG 手术车针	205	2.35mm

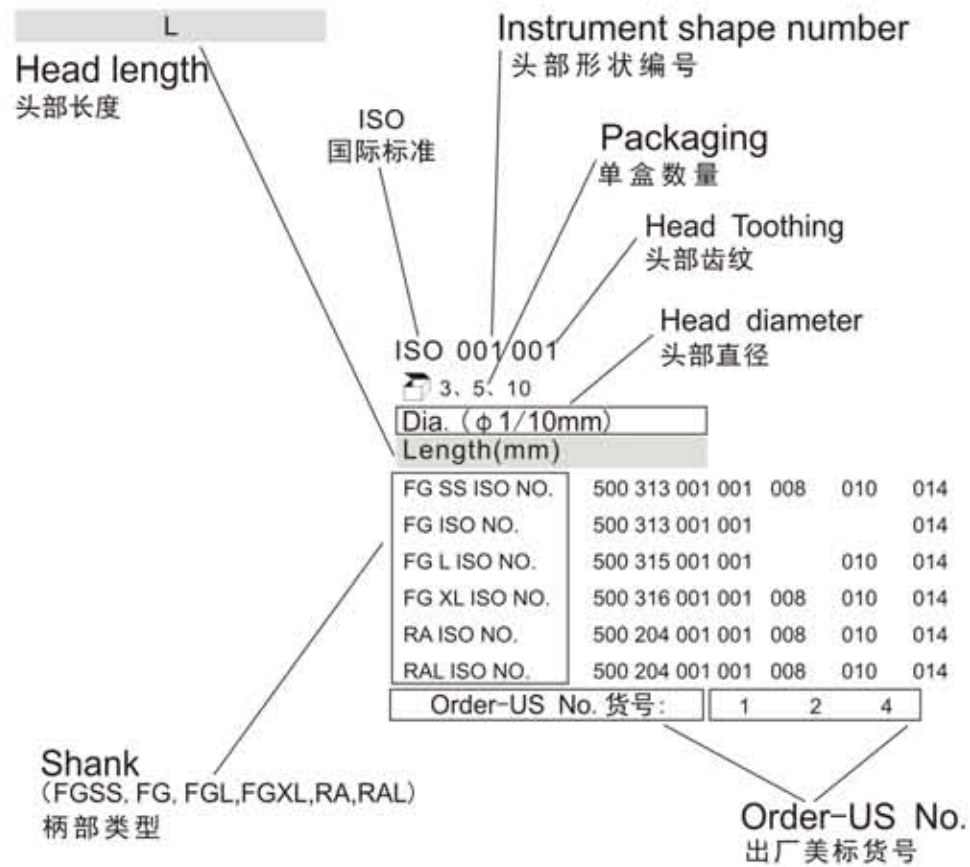
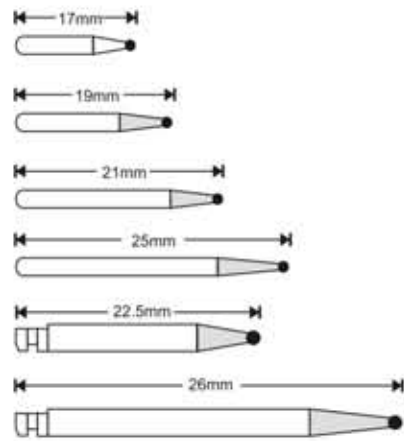

FG.RA 钨钢车针 FG.RA Carbide Burs

ISO 001
☞ 3, 5, 10

Dia. (φ 1/10mm) 头部工作直径	0.8	1.0	1.2	1.4	1.6	1.8	2.1	2.3
Length(mm) 头部工作长度								
FG ISO NO. 500 314 001 001	008	010	012	014	016	018	021	023
FG XL ISO NO. 500 316 001 001		010	012	014		018		023
RA ISO NO. 500 204 001 001	008	010	012	014	016	018	021	023
Order-US No. 订货号:	1	2	3	4	5	6	7	8

ISO 010
☞ 3, 5, 10

Dia. (φ 1/10mm) 头部工作直径	0.8	1.0	1.2	1.4	1.6	1.8	2.1	2.3
Length(mm) 头部工作长度								
FG 500 314 010 001	008	010	012	014	016	018	021	023
RA 500 204 010 001	008	010	012	014	016	018	021	023
Order-US No. 订货号:	34	35	36	37	38	39	40	41

ISO 168
☞ 3, 5, 10

Dia. (φ 1/10mm) 头部工作直径	0.8	0.9	1.0	1.2	1.6	2.1	2.3	1.0	1.2
Length(mm) 头部工作长度	3.8	4.0	4.2	4.2	4.5	5.0	5.0	6.0	6.0
FG 500 314 168 007	008	009	010	012	016	021	023	010	012
FG XL 500 316 168 007				012	016			010	012
RA 500 204 168 007			010	012	016	021	023		
Order-US No. 订货号:	698	699	700	701	702	703	704	701L	702L

ISO 237
☞ 3, 5, 10



Dia. (φ 1/10mm) 头部工作直径	0.6	0.8	1.0	1.2	1.4
Length(mm) 头部工作长度	1.7	1.9	2.0	2.2	2.2
FG ISO NO. 500 314 237 006	006	008	010	012	014
FG XL ISO NO. 500 316 237 006	006	008			
RA ISO NO. 500 204 237 006	006	008	010	012	014
Order-US No. 订货号:	329	330	331	332	333

ISO 139
☞ 3, 5, 10

Dia. (φ 1/10mm) 头部工作直径	0.9
Length(mm) 头部工作长度	2.5
FG ISO NO. 500 314 139 008	009
Order-US No. 订货号:	245



FG.RA 钨钢车针 FG.RA Carbide Burs

ISO 107
☞ 3, 5, 10



Dia. (φ 1/10mm) 头部工作直径	0.8	1.0	1.2	1.4	1.6	1.8	2.1	2.3	1.0	1.2
Length(mm) 头部工作长度	3.8	4.2	4.2	4.5	4.5	4.8	5.0	5.0	6.0	6.0
FG ISO NO.	500 314 107 007	008	010	012	014	016	018	021	023	
FG XL ISO NO.	500 316 107 007		010	012						010 012
RA ISO NO.	500 204 107 007	008	010	012	014	016	018	021	023	
Order-US No. 订货号:	556	557	558	559	560	561	562	563	557L	558L

ISO 107
☞ 3, 5, 10



Dia. (φ 1/10mm) 头部工作直径	0.8	1.0	1.2	1.4	1.6	1.8	2.1	2.3	1.0	1.2
Length(mm) 头部工作长度	3.8	4.2	4.2	4.5	4.5	4.8	5.0	5.0	6.0	6.0
FG ISO NO.	500 314 107 006	008	010	012	014	016	018	021	023	010 012
FG XL ISO NO.	500 316 107 006			012						010 012
RA ISO NO.	500 204 107 006	008	010	012	014	016	018	021	023	
Order-US No. 订货号:	56	57	58	59	60	61	62	63	57L	58L

ISO 168
☞ 3, 5, 10



Dia. (φ 1/10mm) 头部工作直径	0.8	0.9	1.0	1.2	1.6	1.0	1.2
Length(mm) 头部工作长度	3.8	4.0	4.2	4.2	4.5	6.0	6.0
FG ISO NO.	500 314 168 006	008	009	010	012	016	010 012
FG XL ISO NO.	500 316 168 006						010 012
RA ISO NO.	500 204 168 006	008	009	010	012	016	010 012
Order-US No. 订货号:	168	169	170	171	172	170L	171L

ISO 137
☞ 3, 5, 10

Dia. (φ 1/10mm) 头部工作直径	0.9	1.0	1.2	1.4	1.6	1.8
Length(mm) 头部工作长度	4.0	4.2	4.2	4.5	4.5	4.8
FG ISO NO.	500 314 137 006	009	010	012	014	016
RA ISO NO.	500 204 137 006		010	012	014	016 018
Order-US No. 订货号:	1156	1157	1158	1159	1160	1161



ISO 139
☞ 3, 5, 10

Dia. (φ 1/10mm) 头部工作直径	1.0	1.2
Length(mm) 头部工作长度	4.2	4.2
FG ISO NO.	500 314 139 008	010 012
Order-US No. 订货号:	1957	1958

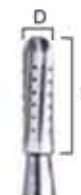

FG.RA 钨钢车针 FG.RA Carbide Burs

ISO 137
☞ 3, 5, 10



Dia. (φ 1/10mm) 头部工作直径	0.9	1.0	1.2	1.4	1.6	1.0	1.2
Length(mm) 头部工作长度	4.0	4.2	4.2	4.5	4.5	6.0	6.0
FG ISO NO.	500 314 137 007	009	010	012	014	016	
FG XL ISO NO.							010 012
RA ISO NO.	500 204 137 007			010	014	016	
Order-US No. 订货号:	1556	1557	1558	1559	1560	1557L	1558L

ISO 194
☞ 3, 5, 10

Dia. (φ 1/10mm) 头部工作直径	1.0	1.2	1.6	1.0	1.2
Length(mm) 头部工作长度	4.2	4.2	4.5	6.0	6.0
FG ISO NO.	500 314 194 007	010	012	016	
FG XL ISO NO.	500 316 194 007				010 012
RA ISO NO.	500 204 194 007		012		
Order-US No. 订货号:	1700	1701	1702	1700L	1701L

Zekrya
ISO 199
☞ 5

Dia. (φ 1/10mm) 头部工作直径	1.6
Length(mm) 头部工作长度	11
FGL ISO NO.	500 315 199 295
FG XL ISO NO.	500 316 199 295
RA ISO NO.	500 204 199 295
Order-US No. 订货号:	Zekrya(151)

Endo-Z
ISO 219
☞ 5



Dia. (φ 1/10mm) 头部工作直径	1.4	1.6
Length(mm) 头部工作长度	9.0	9.0
FGL ISO NO.	500 315 219 295	014 016
FG XL ISO NO.	500 316 219 295	014 016
RA ISO NO.	500 204 219 295	014 016
Order-US No. 订货号:	Endo-Z(152)	

ISO 001
☞ 5, 10



Dia. (φ 1/10mm) 头部工作直径	1.4	1.6	1.8	2.1	2.3
Length(mm) 头部工作长度	1.4	1.6	1.8	2.1	2.3
FG ISO NO.	500 314 001 001	014	016	018	2.1 2.3
Order-US No. 订货号:	7004	7005	7006	7007	7008

ISO 277
☞ 5, 10



Dia. (φ 1/10mm) 头部工作直径	1.4	1.8	2.3
Length(mm) 头部工作长度	2.7	3.5	3.9
FGL ISO NO.	500 314 277 072	014	018 023
FG XL ISO NO.	500 316 277 072		
RA ISO NO.	500 204 277 072		018 023
Order-US No. 订货号:	7404	7405	7406

ISO 254
☞ 5, 10



Dia. (φ 1/10mm) 头部工作直径	1.4	1.8	2.3
Length(mm) 头部工作长度	3.3	4.0	5.0
FGL ISO NO.	500 314 499 072	014	018 023
FG XL ISO NO.	500 316 499 072		
RA ISO NO.	500 204 499 072		018 023
Order-US No. 订货号:	7104	7106	7108

FG.RA 钨钢车针 FG.RA Carbide Burs



ISO 246
5、10

Dia. (φ 1/10mm) 头部工作直径	0.8	1.0	1.2
Length(mm) 头部工作长度	4.0	4.0	4.5
FG ISO NO. 500 314 246	008	010	012
Order-US No. 订货号:	7901	7902	7903



ISO 184
5、10

Dia. (φ 1/10mm) 头部工作直径	1.4	1.6	1.8
Length(mm) 头部工作长度	9.5	9.5	9.5
FG L ISO NO. 500 315 184	014	016	018
Order-US No. 订货号:	7204	7205	7206



ISO 499
5、10

Dia. (φ 1/10mm) 头部工作直径	0.8	1.0	1.2
Length(mm) 头部工作长度	3.5	3.5	4.0
FG ISO NO. 500 314 499	008	010	012
Order-US No. 订货号:	7801	7802	7803



ISO 168
5、10

Dia. (φ 1/10mm) 头部工作直径	1.0	1.2
Length(mm) 头部工作长度	5.5	5.5
FG ISO NO. 500 314 168	010	012
Order-US No. 订货号:	7702	7703



ISO 856
5、10

Dia. (φ 1/10mm) 头部工作直径	1.2	1.4	1.6	1.8	2.1	2.3
Length(mm) 头部工作长度	8.0	8.0	8.0	8.0	8.0	8.0
FGL ISO NO. 500 315 856	012	014	016	018	021	023
Order-US No. 订货号:	856/012	856/014	856/016	856/018	856/021	856/023



ISO 184
5、10

Dia. (φ 1/10mm) 头部工作直径	1.4
Length(mm) 头部工作长度	9.5
FG L ISO NO. 500 315 184	014
Order-US No. 订货号:	7714



ISO 847
5、10

Dia. (φ 1/10mm) 头部工作直径	1.2	1.4	1.6	1.8	2.1	2.3
Length(mm) 头部工作长度	8.0	8.0	8.0	8.0	8.0	8.0
FGL ISO NO. 500 315 847	012	014	016	018	021	023
Order-US No. 订货号:	847/012	847/014	847/016	847/018	847/021	847/023



ISO 217
5、10

Dia. (φ 1/10mm) 头部工作直径	0.1
Length(mm) 头部工作长度	6.0
FG ISO NO. 500 314 217	010
Order-US No. 订货号:	7214

HP低速直柄钨钢车针 HP.Carbide Burs

牙科技工室用直柄车针 (HP): 用于所有金属, 贵金属及树脂磨削, 雕刻磨屑。

Dental HP applied in Technical Worker Room: To be used to grind, carve all the metal, noble metal and resin.

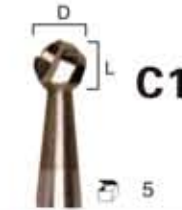

C1
5

Dia. (φ 1/10mm) 头部工作直径	006	008	010	012	014	016	018	021	023
Length(mm) 头部工作长度	0.6	0.8	1.0	1.2	1.4	1.6	1.8	2.1	2.3
ISO NO.500.104.001.001	006	008	010	012	014	016	018	021	023
Order-US No. HP订货号:	12	1	2	3	4	5	6	7	8



C2
5

Dia. (φ 1/10mm) 头部工作直径	008	010	012	014	016	018	021	023
Length(mm) 头部工作长度	0.8	1.0	1.2	1.4	1.6	1.8	2.1	2.3
ISO NO.500.104.010.001	008	010	012	014	016	018	021	023
Order-US No. HP订货号:	34	35	36	37	38	39	40	41



C33
5

Dia. (φ 1/10mm) 头部工作直径	009	010	012	016	021	023
Length(mm) 头部工作长度	3.8	4.2	4.2	4.4	4.9	5.4
ISO NO.500.104.168.007	009	010	012	016	021	023
Order-US No. HP订货号:	699	700	701	702	703	704



C23
5

Dia. (φ 1/10mm) 头部工作直径	009	010	012	016	021	023
Length(mm) 头部工作长度	3.8	4.2	4.2	4.4	4.9	5.4
ISO NO.500.104.168.006	009	010	012	016	021	023
Order-US No. HP订货号:	169	170	171	172	173	174

HP低速直柄钨钢车针 HP.Carbide Burs



C21



Dia.(ϕ 1/10mm) 头部工作直径	008	010	012	014	016	018	021	023
Length(mm) 头部工作长度	3.8	4.2	4.2	4.4	4.4	4.9	4.9	5.4
ISO NO.500.104.107.006	008	010	012	014	016	018	021	023
Order-US No. HP订货号:	56	57	58	59	60	61	62	63



C31



Dia.(ϕ 1/10mm) 头部工作直径	008	010	012	014	016	018	021	023
Length(mm) 头部工作长度	3.8	4.2	4.2	4.4	4.4	4.9	5.1	5.4
ISO NO.500.104.107.007	008	010	012	014	016	018	021	023
Order-US No. HP订货号:	556	557	558	559	560	561	562	563



C21R



Dia.(ϕ 1/10mm) 头部工作直径	008	010	012	014	016	018	021	023
Length(mm) 头部工作长度	4.0	4.0	4.5	4.5	5.0	5.0	5.4	5.4
ISO NO.500.104.137.006	008	010	012	014	016	018	021	023
Order-US No. HP订货号:	1156	1157	1158	1159	1160	1161	1162	1163



C31R



Dia.(ϕ 1/10mm) 头部工作直径	008	010	012	014	016	018
Length(mm) 头部工作长度	4.0	4.0	4.5	4.5	5.0	5.0
ISO NO.500.104.137.007	008	010	012	014	016	018
Order-US No. HP订货号:	1556	1557	1558	1559	1560	1561

C33L



Dia.(ϕ 1/10mm) 头部工作直径	009	010	012	016	021
Length(mm) 头部工作长度	5.3	6.3	6.3	6.3	6.3
ISO NO.500.104.171.007	009	010	012	016	021
Order-US No. HP订货号:	699L	700L	701L	702L	703L

CNC 钨钢磨头订货范例 CNC Carbide Burs Order Range



Order Instruction

订货说明:
出厂编号(order NO): **F060GX**

Burs shape (F)
磨头形状(F)
磨头的齿型是标准交叉纹
Standard of the burs tooth number
磨头的直径(D) 6mm
Burs diameter (D) 6mm

国际编号: (ISO NO).500 104 274 190 060

Dia.(ϕ 1/10mm) 头部工作直径	060
Length(mm) 头部工作长度	14
ISO NO.500.104.	274.190 060
Order NO.订货号	F060GX

直径(D)6mm
Diameter (D) 6mm
齿数: 标准单刃
Tooth number:
standard single blade
磨头形状 (F)
Burs shape(F)
柄的直径/长度 (2.35mm/44.5mm)
Shank diameter/length (2.35mm/44.5mm)
磨头材质: 硬质合金
Burs material, Carbide

标示说明 Specification	编码 Abbr.	代码 Code	颜色码 Color Code	齿数规格 Cut size	用途 Application
极细 Superfine	EX	110	黄 Yellow	极细纹单刃、双刃 Cut/Crosscut	用于非贵金属、贵金属、复合材料 Non precious alloys/Precious alloys/Composites material
细 Fine	FX	140	红 Red	极细纹单刃、双刃 Cut/Crosscut	用于非贵金属、贵金属、复合材料 Non precious alloys/Precious alloys/Composites material
标准单刃 Medium Cut	S	175	蓝 Blue	标准单刃 Cut	用于丙烯酸树脂、石膏、非贵金属、贵金属 Non precious alloys/Precious alloys/Composites material
标准双刃 Medium Crosscut	GX	190	蓝 Blue	标准双刃(交叉齿) Cross Cut	用于丙烯酸树脂、石膏 All acrylics /Composites / Plaster
粗齿单刃 Coarse Cut	G	215	绿 Green	粗齿单刃 Coarse Cut	用于丙烯酸树脂、石膏 All acrylics /Composites / Plaster
粗齿双刃 Coarse Crosscut	HX	220	绿 Green	粗齿双刃(交叉齿) Coarse Crosscut	用于丙烯酸树脂、石膏 All acrylics /Composites / Plaster
极粗 Extra-coarse			黑 Black		

备注说明: 可按样加工其他齿纹工艺磨头, 如细齿、粗齿螺旋纹等纹路。
Remarks: Accept customers drawings and samples to produce.

说明: 锐鑫出厂产品, 均有唯一的出厂编号和国际标准编号, 客户可以选择出厂编号订货, 或选择国际标准编号订货。

Explanation: All the products of Ruixin have the only order No. and ISO NO., clients could choose order NO. or ISO NO. to order.

HP.CNC 钨钢磨头 HP.CNC Carbide Burs

双纹“X”，中牙，(ISO-编号, 190)，蓝圈，用于切屑大面积合金及丙烯酸一树脂。

Crosscut, medium, (ISO-NO.190) blue ring, apply to cut extensive alloy and acrylics.



Dia.(φ1/10mm)头部工作直径	023	050	060	060	060	060	060
Length(mm)头部工作长度	11.5	4.5	5.5	13	10	11	12
HP ISO NO.500.104.	194.190 023	001.190 050	001.190 060	144.190 060	277.190 060	239.190 060	257.190 060
Order NO.订货号	L02311GX	D050GX	D060GX	C060GX	E060GX	CN060GX	G060GX



Dia.(φ1/10mm)头部工作直径	023	023	023	023	023	023	023	023
Length(mm)头部工作长度	5.5	5.5	5.5	2.3	5.5	5.5	5.5	5.5
HP ISO NO.500.104.	114.190 023	194.190 023	225.190 023	001.190 023	237.190 023	257.190 023	144.190 023	287.190 023
Order NO.订货号	A023GX	L023GX	N023GX	D023GX	CN023GX	G023GX	C023GX	FA023GX



Dia.(φ1/10mm)头部工作直径	060	060	023	023	023
Length(mm)头部工作长度	13	14	14	14	14
HP ISO NO.500.104.	107.190.060	161.190 060	109.190 023	144.190 023	192.190 023
Order NO.订货号	A060GX	M060GX	A02314GX	C02314GX	FA02314GX



Dia.(φ1/10mm)头部工作直径	040	050	060	023	023	023	040	060
Length(mm)头部工作长度	13	13	13	8	8	8	13	14
HP ISO NO.500.104.	194.190 040	194.190 045	194.190 060	141.190 023	198.190 023	289.190 023	275.190 040	274.190 060
Order NO.订货号	L040GX	L045GX	L060GX	C02308GX	L02308GX	FA02308GX	H040GX	F060GX

HP.CNC 钨钢磨头 HP.CNC Carbide Burs

单纹，中牙，(ISO-编号, 175)，蓝圈，高效切屑硬质金属并能切屑出平滑的效果。

Cut, medium, (ISO-NO.175), blue ring, cut carbide effectively and smoothly.



Dia.(φ1/10mm)头部工作直径	060	016	023	023	030	040	050	060	060	060
Length(mm)头部工作长度	13	9.5	11.5	2.3	3	4	5	13.7	10	14
HP ISO NO.500.104.	107.175.060	143.175.016	194.175.023	001.175.023	001.175.030	001.175.040	001.175.050	143.175.060	277.175.060	275.175.060
编号:Order NO	A060S	C016S	L023S	D023S	D030S	D040S	D050S	C060S	E060S	



Dia.(φ1/10mm)头部工作直径	060	060	060	040	050	060	040
Length(mm)头部工作长度	11	11	12	13	13	13	13
HP ISO NO.500.104.	237.175 050	237.175 060	257.175 060	194.175 040	194.175 045	194.175 060	277.175.040
编号:Order NO	CN050S	CN060S	G060S	L040S	L045S	L060S	H040S



Dia.(φ1/10mm)头部工作直径	060	060	023
Length(mm)头部工作长度	14.00	14.00	14.00
HP ISO NO.500.104.	274.175 060	161.175 060	187.175 023
编号:Order NO	F060S	M060S	MA023S

单纹，粗牙，(ISO-编号, 215)，绿圈，迅速高效切屑，丙烯酸一树脂，石膏等非金属材料。

Cut, coarse, (ISO-NO.215), green ring, cut acrylics, plaster and such nonmetal material rapidly and effectively



Dia.(φ1/10mm)头部工作直径	060	050	060	060	060	060
Length(mm)头部工作长度	13	13	13	14.00	11	10.00
HP ISO NO.500.104.	143.215 060	194.215 045	194.215 060	274.215 060	237.175 060	277.175.060
编号: Order NO	C060G	L045G	L060G	F060G	CN060G	E060G

HP.CNC 钨钢磨头 HP.CNC Carbide Burs



Dia.(φ1/10mm)头部工作直径	023	023	023	023	040	023	023	023	023	023	016
Length(mm)头部工作长度	11.50	5.50	5.50	5.50	13	8.00	8.00	8.00	14.00	14.00	8.00
HP ISO NO.500.104.	194.110.023	225.110.023	237.110.023	275.110.023	194.110.040	143.110.023	198.110.023	289.110.023	143.110.023	292.110.023	184.110
编号:Order NO	L02311EX	N023EX	CN023EX	H023EX	L040EX	C023EX	L02308EX	FA02308EX	C02314EX	FA02314EX	L016EX



Dia.(φ1/10mm)头部工作直径	040	023	016	023	060	050
Length(mm)头部工作长度	13	15.0	8.0	16.0	13.0	13.0
HP ISO NO.500.104.	277.110.040	194.110.023	198.110.016	187.110.023	194.110.060	194.110.050
编号:Order NO	H040FX	L023EX	L016EX	MA023EX	L060EX	L050EX



Dia.(φ1/10mm)头部工作直径	023	060	060	060	040	045	060	023	016
Length(mm)头部工作长度	11.50	13	11	12	13	13	13	8.00	8.00
HP ISO NO.500.104.	194.140.023	143.140.060	237.140.060	257.140.060	194.140.040	194.140.045	194.140.060	143.140.023	198.140.011
编号:Order NO	L02311FX	C060FX	CN060FX	G060FX	L040FX	L045FX	L060FX	C02308FX	L016FX



Dia.(φ1/10mm)头部工作直径	023	023	023	023	014	023	023
Length(mm)头部工作长度	5.50	5.50	5.50	4.10	5.50	4.75	5.50
HP ISO NO.500.104.	113.140.023	194.140.023	225.140.023	277.140.023	237.140.023	143.140.014	144.140.023
编号:Order NO	B02305FX	L023FX	N023FX	E023FX	CN023FX	C014FX	C023FX



Dia.(φ1/10mm)头部工作直径	023	023	040	040	060	023	023	023	023
Length(mm)头部工作长度	8.00	8.00	13	9.30	14.00	14.00	14.00	14.00	14.00
HP ISO NO.500.104.	198.140.023	289.140.023	277.140.040	274.140.040	274.140.060	114.140.023	143.140.023	292.140.023	187.140.023
编号:Order NO	L02308FX	FA02308FX	H040FX	F040FX	F060FX	A023FX	C02314FX	FA02314FX	MA023FX

HP.CNC 钨钢磨头 HP.CNC Carbide Burs

双纹“X”，粗牙，(ISO-编号，220)，绿圈，用于切屑大面积丙烯酸—树脂牙托及石膏。
Crosscut, coarse, (ISO-NO.220), green ring, apply to cut extensive alloy and acrylics denture and plaster.



Dia.(φ1/10mm)头部工作直径	060	060	040	045	060
Length(mm)头部工作长度	13	11	13	13	14
HP ISO NO.500.104.	143.220.060	237.220.060	194.220.040	194.220.045	274.220.060
编号: Order NO	C060HX	CN060HX	L040HX	L045HX	F060HX

极粗双纹，(ISO-编号223) 黑色环，用于丙烯酸树脂、石膏。
Cross-cut (ISO-Number)black ring, apply to Acrylics, plaster



Dia.(φ1/10mm)头部工作直径	060	060	060
Length(mm)头部工作长度	13	14	11
HP ISO NO.订货号500.104.	143.223.060	274.223.060	237.223.060



Dia.(φ1/10mm)头部工作直径	060	023	040	040	023
Length(mm)头部工作长度	14	11.5	13	12	14
HP ISO NO.订货号500.104.	274.176.060	194.176.023	194.176.040	277.176.040	143.176.023

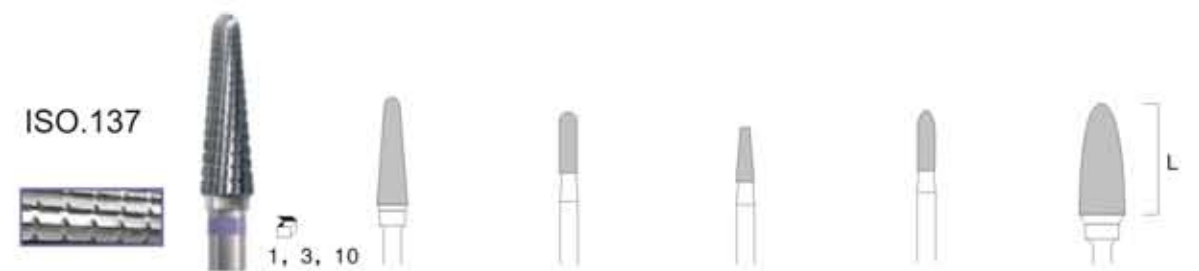

Dia.(φ1/10mm)头部工作直径	040	023	023	023	060
Length(mm)头部工作长度	13	8	8	8	13
HP ISO NO.订货号500.104.	194.137.040	143.137.023	187.137.023	289.137.023	274.137.060

HP.CNC 钨钢磨头 HP.CNC Carbide Burs

ISO.134

Dia.(ϕ 1/10mm) 头部工作直径	040	060	023	023	040	060	023
Length(mm) 头部工作长度	13	13	8.00	8.00	13	14.00	14.00
HP ISO NO.订货号500.104.	194 134 040	194.134 060	143.134 023	198 134 023	277 134 040	274 134 060	194 134 023

钨钢磨头 "CARBIDE BURS"

单支包装 1
Packed 1 per unit



Dia/Length(mm)	12/26mm	12/32mm	12/26mm	12/22mm	12/26mm	9.5/19mm	9.5/26mm	9.5/20mm	9.5/16mm	9.5/30mm
Order No/订货号	F12M	L12M	G12M	E12M	A12M	F10M	L10M	G10M	E10M	A10M

有钛层的钨钢磨头

Carbide bur covered by titanium layer.



Dia/Length(mm)	12/26mm	12/32mm	12/26mm	12/22mm	12/26mm	9.5/19mm	9.5/26mm	9.5/20mm	9.5/16mm	9.5/30mm
Us Order No	8071	8072	8073	8074	8075	8081	8082	8083	8084	8085
Order No/订货号	F12MT	L12MT	G12MT	E12MT	A12MT	F10MT	L10MT	G10MT	E10MT	A10MT

HP.CNC 钨钢磨头 HP.CNC Carbide Burs

有钛层的钨钢磨头

Carbide bur covered by titanium layer

ORDER NO	T289 140 023	T194 110 040	T161 176 060	T194 190 040	T194 190 045	T194 190 050	T194 190 060	T257 190 060	T274 190 060	T144 220 060	T274 220 060	T277 134 014	T289 134 023	T194 134 040	T274 134 060	T194 140 040	T194 140 045	T194 140 050	T194 140 060	T257 140 060	T274 140 060	T198 140 040	T277 140 040
	●	●	●	●	●	●	●	●	●	●	●	●	●	●	●	●	●	●	●	●	●	●	●

HP精密心轴、不生锈、自定中心

HP exact mandrel , rustless, user-defined center

订货号 ORDER NO.	042	043	044	045	046	047
------------------	-----	-----	-----	-----	-----	-----

FG.RA电镀金刚石车针 FG.RA Diamond Burs

国际标准说明：电镀金刚石车针为例

ISO Instruction: Plated Diamond Burs:

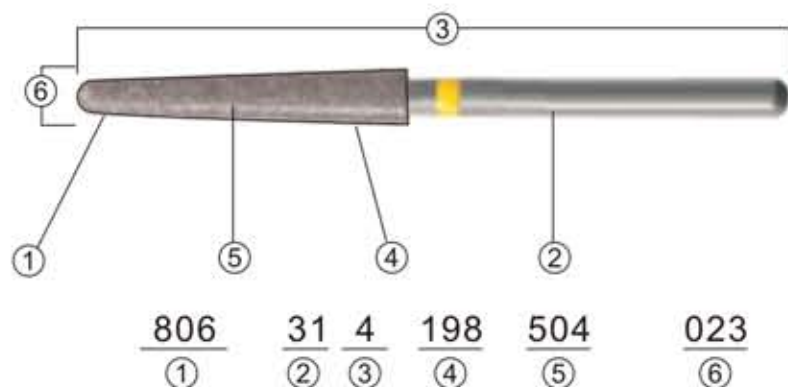

序号 NO.	特性 Character	编码说明 Explain Code	备注 Remarks
①	工作部材质 Working side Material	80 金刚石 Diamond	
	黏合剂 Adhesive	6 电镀金属黏合剂 Plating metal adhesive	
②	柄的型号 Shank Size	31 FG 柄 Shank 1.6mm	参考标准 Reference standards: ISO 1797-1
③	总体长度 Total Length	4 标准长度 Standard length 19mm	
④	工作部形状 Working side Shape	198 顺锥圆头 Suitable cone round head	
⑤	砂粒规格 Grain Size	504 特细 Very fine	494 超细 Super Fine 504 特细 Extra Fine 514 中粗 Medium Coarse 534 粗 Coarse 544 特粗 Extra Coarse
⑥	工作直径 Working side Diameter	023 工作直径 Nominal diameter 2.3mm	参考标准 Reference standards: ISO 2157

FG.RA电镀金刚石车针 FG.RA Diamond Burs

用途: 用于临床各种牙体预备打磨

Application: For polishing kinds of clinical tooth preparation.

注意: 请在推荐转速内安全使用, 方可达到最佳效果。

Note: Please use it in the recommended speed, so that can attain to a best effect.

金刚石粒度表 Diamond Grain Size Sheet	电镀金刚石车针使用转速表 Electroplated Diamond Burs Using Revolutions Per Minute Sheet		
	工作直径 1/10mm Working Diameter	推荐转速 (rpm) Recommended speed	最大转速 (rpm) Maximum speed
■ 特粗 (ISO 544) EC	009-011	75,000-150,000	450,000
■ 粗 (ISO 534) 125-150 μm C	012-016	60,000-110,000	450,000
■ 中粗 (ISO 524) 106-125 μm M	017-020	45,000-85,000	300,000
■ 细 (ISO 514) 53-63 μm F	021-023	40,000-75,000	300,000
■ 极细 (ISO 504) 20-30 μm EF	024-026	20,000-45,000	160,000
■ 超细 (ISO 494) UF	028-030	25,000-45,000	140,000
	033-038	20,000-40,000	120,000
	042-055	17,000-30,000	90,000

标志说明 Specification.	编码 Abbr.	颜色码 Color Code	砂粒规格范围 Sand specifications μm (微米)	粒度规格中间值 Grain Size Median μm (微米)	砂粒标示 Grain Explain
超细. 494 Super Fine	UF	白 White	4~14	8	M4 ~ M14
特细. 504 Extra Fine	EF	黄 Yellow	10~36	25	M10 ~ M36
细. 514 Fine	F	红 Red	27~76	46	M27 ~ D76
中粗. 524 Midium Coarse	M	蓝 Blue	64~126	107	D64 ~ D126
粗. 534 Coarse	C	绿 Green	107~181	151	D107 ~ D181
特粗. 544 Super Coarse	EC	黑 Black	151~213	181	D151 ~ D213

FG.RA电镀金刚石车针 FG.RA Diamond Burs



5, 10

Dia(1/10mm)	0.8	1.0	1.2	1.4	1.6	1.8	2.0	1.4	1.8
Length(mm)	0.8	1.0	1.2	1.4	1.6	1.8	2.0	1.4	1.8
ISO NO.806.314	001.524.008	001.524.010	001.524.012	001.524.014	001.524.016	001.524.018	001.524.020	002.524.014	002.524.018
Order NO.订货号:	BR-49	BR-45	BR-46	BR-41	BR-40	BR-31	BR-28	BC-42	BC-31



5, 10

Dia(1/10mm)	0.9	1.0	1.2	1.4	1.6	1.8	2.1	1.4	1.6
Length(mm)	4.0	4.2	4.2	14.2	4.2	5.2	5.2	7.0	7.0
ISO NO.806.314	169.524.009	169.524.010	170.524.012	170.524.014	170.524.016	170.524.018	170.524.021	171.524.014	171.524.016
Order NO.订货号:	TF-40	TF-41	TF-42	TF-43	TF-31	TF-23	TF-22	TF-20	TF-21



5, 10

Dia(1/10mm)	1.4	1.6	1.8	2.3	1.0	1.2	1.4	1.6
Length(mm)	10.0	10.0	10.0	9.0	8.5	8.5	8.5	8.5
ISO NO.806.314	173.524.014	173.524.016	173.524.018	173.524.023	174.524.010	174.524.014	175.524.016	175.524.018
Order NO.订货号:	TF-11	TF-12	TF-13	TF-14	TF-07	TF-08	TF-09	TF-10



5, 10

Dia(1/10mm)	1.0	1.2	1.4	1.6	1.8	2.2	2.2	1.4	1.6
Length(mm)	4.8	4.8	10.2	10.2	9.0	9.0	10.5	7.0	7.2
ISO NO.806.314	197.524.010	197.524.012	199.524.014	199.524.016	198.524.018	198.524.022	198.524.022	197.524.014	197.524.018
Order NO.订货号:	TR-08	TR-09	TR-11	TR-12	TR-13	TR-14	TR-15	TR-20	TR-21



5, 10

Dia(1/10mm)	2.0	3.0	1.8	1.8	1.4	1.6	1.8	2.0
Length(mm)	3.0	4.5	8.5	7.2	8.0	9.0	6.4	6.4
ISO NO.806.314	276.524.020	276.524.030	198.524.018	197.524.018	199.524.014	200.524.016	198.524.018	198.524.020
Order NO.订货号:	TR-22M	TR-28M	TR-23M	TR-24M	TR-25M	TR-26M	TR-62M	TR-63M

FG.RA电镀金刚石车针 FG.RA Diamond Burs



5, 10

Dia(1/10mm)	1.0	1.2	1.4	1.6	1.8	1.4	1.8	1.2	1.4
Length(mm)	1.0	1.8	2.0	2.0	2.3	3.8	5.0	2.3	3.3
ISO NO.806.314	010.524.010	010.524.012	010.524.014	010.524.016	010.524.018	012.524.018	014.524.018	019.524.010	019.524.014
Order NO.订货号:	SI-45	SI-46	SI-47	SI-48	SI-49	SI-50	SI-51	DI-41	DI-42



5, 10

Dia(1/10mm)	1.8	4.5	4.0	5.0	4.2	2.3	3.8	5.0	3.2
Length(mm)	0.8	0.7	2.2	2.2	2.0	1.2	1.4	2.0	5.3
ISO NO.806.314	043.524.018	044.524.045	043.524.040	043.524.050	068.524.042	304.524.023	304.524.038	304.524.050	308.524.032
Order NO.订货号:	WR-43	WR-44	WR-45	WR-46	WR-13	WR-47	WR-48	WR-49	WR-26



5, 10

Dia(1/10mm)	1.2	1.4	1.2	1.4	1.6	1.8	2.8	3.2
Length(mm)	6.0	6.0	10	7.2	7.2	8.5	5.0	5.3
ISO NO.806.314	253.524.012	253.524.014	298.524.012	298.524.014	298.524.016	254.524.016	257.524.028	257.524.032
Order NO.订货号:	FO-41	FO-20	FO-11	FO-21	FO-22	FO-32	FO-25	FO-27



5, 10

Dia(1/10mm)	1.6	1.4	1.2	1.0	1.4	0.7
Length(mm)	8.0	8.0	6.0	9.0	9.0	4.0
ISO NO.806.314	160.524.016	160.524.014	160.524.012	160.524.010	167.524.014	160.524.007
Order NO.订货号:	TC-11	TC-21	TC-26	TC-27	TC-28	TC-57



5, 10

Dia(1/10mm)	1.0	1.2	1.4	1.4	1.6	1.2	1.4	1.6	1.2
Length(mm)	4.0	4.0	4.0	7.0	7.0	8.2	8.2	8.2	9.5
ISO NO.806.314	109.524.010	109.524.012	109.524.016	110.524.014	110.524.016	111.524.012	111.524.014	111.524.016	150.524.012
Order NO.订货号:	SF-41	SF-31	SF-42	SF-21	SF-15	SF-11	SF-12	SF-13	SF-05

FG.RA电镀金刚石车针 FG.RA Diamond Burs



5, 10

Dia(1/10mm)	1.0	1.2	1.4	1.6	1.6	1.0	1.2	1.4
Length(mm)	8.5	8.5	7.0	7.2	5.2	4.2	4.2	4.2
ISO NO.806.314	174.524.010	174.524.012	171.524.014	171.524.016	170.524.016	001.524.014	170.524.012	170.524.014
Order NO.订货号:	TF-S07	TF-S08	TF-S20	TF-S21	TF-S31	TF-S41	TF-S42	TF-S43



5, 10

Dia(1/10mm)	1.2	1.4	1.2	1.4	1.2	1.4
Length(mm)	1.8	2.0	1.2	1.4	8.2	8.0
ISO NO.806.314	010.524.012	010.524.014	001.524.012	001.524.014	111.524.012	160.524.014
Order NO.订货号:	SI-S46	SI-S47	BR-S46	BR-S41	SF-S11	TC-S21



5, 10

Dia(1/10mm)	1.0	1.4	1.8	2.1	3.2	3.5
Length(mm)	3.5	4.0	5.0	5.0	5.0	7.0
ISO NO.806.314	237.524.014	234.524.014	234.524.018	234.524.021	039.524.032	039.524.035
Order NO.订货号:	TF-41	EX-31	EX-20	EX-21	EX-11	EX-12



5, 10

Dia(1/10mm)	1.0	1.2	1.4	1.2	1.4	1.6	1.6	1.4	1.6
Length(mm)	5.6	7.5	7.5	8.2	8.2	8.0	5.0	8.5	8.5
ISO NO.806.314	288.524.010	288.524.012	289.524.014	141.524.012	141.524.014	141.524.016	254.524.016	515.524.014	519.524.016
Order NO.订货号:	SO-19	SO-20	SO-21	SR-11	SR-12	SR-13	CR-12	BC-11	BC-12



5, 10

Dia(1/10mm)	1.2	1.4	1.6	1.8	2.0	1.2	1.4	1.6	1.8
Length(mm)	1.2	1.4	1.6	1.8	2.0	1.8	2.0	2.0	2.3
ISO NO.806.314	001.534.012	001.534.014	001.534.016	001.534.018	001.534.020	010.534.012	010.534.014	010.534.016	010.534.018
Order NO.订货号:	BR-46C	BR-41C	BR-40C	BR-31C	BR-28C	SI-46C	SI-47C	SI-48C	SI-49C

FG.RA电镀金刚石车针 FG.RA Diamond Burs



5, 10

Dia(1/10mm)	1.4	1.6	1.8	2.3	1.0	1.2	1.4	1.6	1.8
Length(mm)	10.0	10.0	10.0	9.0	8.5	8.5	8.5	8.5	8.5
ISO NO.806.314	173.534.014	173.534.016	173.534.018	173.534.023	174.534.010	174.534.014	175.534.016	175.534.018	175.534.018
Order NO.订货号:	TF-11C	TF-12C	TF-13C	TF-14C	TF-07C	TF-08C	TF-09C	TF-10C	TF-56C



5, 10

Dia(1/10mm)	1.0	1.2	1.4	1.6	1.8	2.2	2.2	1.4	1.6
Length(mm)	4.8	4.8	10.2	10.2	9.0	9.0	10.5	7.0	7.2
ISO NO.806.314	197.534.010	197.534.012	199.534.014	199.534.016	198.534.018	198.534.022	198.534.022	197.534.014	197.534.016
Order NO.订货号:	TR-08C	TR-09C	TR-11C	TR-12C	TR-13C	TR-14C	TR-15C	TR-20C	TR-21C



5, 10

Dia(1/10mm)	1.0	1.2	1.4	1.4	1.6	1.2	1.4	1.6	1.2
Length(mm)	4.0	4.0	4.0	7.0	7.0	8.2	8.2	8.2	9.5
ISO NO.806.314	109.534.010	109.534.012	109.534.016	110.534.014	110.534.016	111.534.012	111.534.014	111.534.016	156.534.012
Order NO.订货号:	SF-41C	SF-31C	SF-42C	SF-21C	SF-15C	SF-11C	SF-12C	SF-13C	SF-05C



5, 10

Dia(1/10mm)	1.8	4.5	4.0	5.0	4.2	2.3	3.8	5.0	3.2
Length(mm)	0.8	0.7	2.2	2.2	2.0	1.2	1.4	2.0	5.3
ISO NO.806.314	043.534.018	044.534.045	043.534.040	043.534.050	068.534.042	304.534.023	304.534.038	304.534.050	308.534.032
Order NO.订货号:	WR-43C	WR-44C	WR-45C	WR-46C	WR-13C	WR-47C	WR-48C	WR-49C	WR-26C



5, 10

Dia(1/10mm)	1.2	1.4	1.2	1.4	1.6	1.8	2.8	3.2
Length(mm)	6.0	6.0	10	7.2	7.2	8.5	5.0	5.3
ISO NO.806.314	253.534.012	253.534.014	298.534.012	298.534.014	298.534.016	254.534.016	257.534.028	257.534.032
Order NO.订货号:	FO-41C	FO-20C	FO-11C	FO-21C	FO-22C	FO-32C	FO-25C	FO-27C

FG.RA电镀金刚石车针 FG.RA Diamond Burs



Dia(1/10mm)	1.6	1.4	1.2	1.0	1.4	0.7
Length(mm)	8.0	8.0	6.0	9.0	9.0	4.0
ISO NO.806.314	160.534.016	160.534.014	160.534.012	160.534.010	167.534.014	160.534.007
Order NO.订货号:	TC-11	TC-21	TC-26	TC-27	TC-28	TC-57



Dia(1/10mm)	1.4	1.6	1.4	1.6	1.8	1.4	1.6	1.4	1.6
Length(mm)	6.5	6.5	10.0	10.0	10.0	6.0	6.2	10.2	10.2
ISO NO.806.314	172.534.014	172.534.016	173.534.014	173.534.016	173.534.018	198.534.014	198.534.016	202.534.014	202.534.018
Order NO.订货号:	TF-20CR	TF-21CR	TF-11CR	TF-12CR	TF-13CR	TR-20CR	TR-21CR	TR-11CR	TR-12CR



Dia(1/10mm)	1.0	1.2	1.4	1.8	1.4	1.6	1.8	1.6
Length(mm)	4.8	4.8	10.2	9.0	7.0	7.2	6.4	10
ISO NO.806.314	197.514.010	197.514.012	199.514.014	198.514.018	197.514.014	197.5214.018	198.514.018	160.514.018
Order NO.订货号:	TR-08F	TR-09F	TR-11F	TR-13F	TR-20F	TR-21F	TR-62F	TC-11F



Dia(1/10mm)	1.0	1.4	1.6	1.8	1.4	1.6	2.8	1.2
Length(mm)	8.5	8.5	10.0	10.0	6.5	6.5	5.0	9.5
ISO NO.806.314	174.514.010	175.514.016	173.514.016	173.514.018	171.514.014	171.514.016	257.514.028	180.514.012
Order NO.订货号:	TF-07F	TF-09F	TF-12F	TF-13F	TF-20F	TF-21F	FO-25F	SF-05F



Dia(1/10mm)	1.2	1.4	1.6	1.8	1.2	1.4	1.4	1.6	3.2
Length(mm)	10	7.2	7.2	4.0	6.0	8.0	9.0	10.2	5.0
ISO NO.806.314	299.504.012	298.504.014	298.504.016	257.504.018	160.504.012	160.504.014	167.504.014	199.504.016	308.504.032
Order NO.订货号:	FO-11EF	FO-21EF	FO-22EF	FO-32EF	TC-26EF	TC-21EF	TC-27EF	TR-12EF	WR-26EF

FG.RA电镀金刚石车针 FG.RA Diamond Burs



Dia(1/10mm)	1.2	1.4	1.6	1.8	2.0	1.2	1.4	1.6	1.8
Length(mm)	1.2	1.4	1.6	1.8	2.0	1.8	2.0	2.0	2.3
ISO NO.806.314	001.544.012	001.544.014	001.544.016	001.544.018	001.544.020	010.544.012	010.544.014	010.544.016	010.544.018
Order NO.订货号:	BR-46EC	BR-41EC	BR-40EC	BR-31EC	BR-28EC	SI-46EC	SI-47EC	SI-48EC	SI-49EC



Dia(1/10mm)	1.4	1.6	1.8	2.3	1.0	1.2	1.4	1.6	1.8
Length(mm)	10.0	10.0	10.0	9.0	8.5	8.5	8.5	8.5	8.5
ISO NO.806.314	173.544.014	173.544.016	173.544.018	173.544.023	174.544.010	174.544.014	175.544.016	175.544.018	175.544.018
Order NO.订货号:	TF-11EC	TF-12EC	TF-13EC	TF-14EC	TF-07EC	TF-08EC	TF-09EC	TF-10EC	TF-56EC



Dia(1/10mm)	1.0	1.2	1.4	1.6	1.8	2.2	2.2	1.4	1.6
Length(mm)	4.8	4.8	10.2	10.2	9.0	9.0	10.5	7.0	7.2
ISO NO.806.314	197.544.010	197.544.012	199.544.014	199.544.016	198.544.018	198.544.022	198.544.022	197.544.014	197.544.018
Order NO.订货号:	TR-08EC	TR-09EC	TR-11EC	TR-12EC	TR-13EC	TR-14EC	TR-15EC	TR-20EC	TR-21EC



Dia(1/10mm)	1.0	1.2	1.4	1.4	1.6	1.2	1.4	1.6	1.2
Length(mm)	4.0	4.0	4.0	7.0	7.0	8.2	8.2	8.2	9.5
ISO NO.806.314	109.544.010	109.544.012	109.544.016	110.544.014	110.544.016	111.544.012	111.544.014	111.544.016	150.544.012
Order NO.订货号:	SF-41EC	SF-31EC	SF-42EC	SF-21EC	SF-15EC	SF-11EC	SF-12EC	SF-13EC	SF-05EC



Dia(1/10mm)	1.2	1.4	1.2	1.4	1.6	1.8	2.8	3.2
Length(mm)	6.0	6.0	10	7.2	7.2	8.5	5.0	5.3
ISO NO.806.314	253.544.012	253.544.014	298.544.012	298.544.014	298.544.016	254.544.016	257.544.028	257.544.032
Order NO.订货号:	FO-41EC	FO-20EC	FO-11EC	FO-21EC	FO-22EC	FO-32EC	FO-25EC	FO-27EC

FG.RA电镀金刚石车针 FG.RA Diamond Burs

用途: 用于临床各种牙体预备打磨
Application: For polishing kinds of clinical tooth preparation.

5、10



Dia(1/10mm) 头部工作直径	1.0	1.4	1.8	2.3	1.2	1.0	1.2
Length(mm) 头部工作长度	1.0	1.4	1.8	2.3	1.5	3.5	3.5
ISO NO.806.204.524	001 010	001 014	001 018	001 023	010 015	108 010	108 012
Order NO.订货号:	BR-45	BR-41	BR-31	BR-26	SI-46	SF-41	SF-31

5、10



Dia(1/10mm) 头部工作直径	1.4	1.6	1.6	1.8	1.4	1.8	4.2
Length(mm) 头部工作长度	7	6	8	10	10	10	2
ISO NO.806.204.524	171 014	171 016	172 016	199 018	166 014	166 018	068 042
Order NO.订货号:	TF-20	TF-21	TF-10	TR-13	TC-10	TC-16	WR-13

5、10



Dia(1/10mm) 头部工作直径	1.4	1.6	1.8	2.3	2.8	1.8	1.6	1.6
Length(mm) 头部工作长度	1.4	1.6	1.8	2.3	5	8.5	8	6
ISO NO.806.204.334	001 014	001 016	001 018	001 023	257 028	257 018	250 016	171 018
Order NO.订货号:	BR-41C	BR-40C	BR-31C	BR-26C	FO-25C	FO-32C	TC-41C	TF-21C

5、10



Dia(1/10mm) 头部工作直径	2.8	1.8	1.2	1.6	1.2	1.6	1.0
Length(mm) 头部工作长度	5	3.5	6	7.2	10	8.0	9
ISO NO.806.204.314	257 028	257 018	257 012	249 016	298 012	160 016	250 016
Order NO.订货号:	FO-25F	FO-32F	FO-41F	FO-22F	FO-11F	TC-11F	TC-27F

5、10



Dia(1/10mm) 头部工作直径	2.8	1.8	1.2	1.6	1.2	1.6	1.0
Length(mm) 头部工作长度	5	3.5	6	7.2	10	8.0	9
ISO NO.806.204.504	257 028	257 018	257 012	249 016	298 012	160 016	250 016
Order NO.订货号:	FO-25EF	FO-32EF	FO-41EF	FO-22EF	FO-11EF	TC-11EF	TC-27EF

电镀HP金刚砂磨头 Electroplated HP diamonds Burs

250



ISO 250 524

Head Dia(1/10mm)	016	018	025	045	050	055	060	060	070	080	090	100
Length(mm)	10	10	10	8	10	12	11	13	12	13	13	13
ISO NO.订货号 806 104	250 016	250 018	250 025	250 045	250 050	250 055	250 060	250 060	250 070	250 080	250 090	250 100

368



ISO 368 524

Head Dia(1/10mm)	021	023	037	060	070
Length(mm)	8	5	10	13	13
ISO NO.订货号 806 104	368 021	368 023	368 037	368 060	368 070

852



ISO 852 524

Head Dia(1/10mm)	025	037	057
Length(mm)	8.5	6	9
ISO NO.订货号 806 104	852 025	852 037	852 057

805



ISO 805 524

Head Dia(1/10mm)	018	021	027	040	050	060	093
Length(mm)	0.6	0.7	1	1.5	2.8	2	3.5
ISO NO.订货号 806 104	805 018	805 021	805 027	805 040	805 050	805 060	805 093

807



ISO 807 524

Head Dia(1/10mm)	018	021	025
Length(mm)	5	5	6
ISO NO.订货号 806 104	807 018	807 021	807 025

803



ISO 803 524

Head Dia(1/10mm)	014	016	018	021	025
Length(mm)	1.6	1.6	1.6	2	2
ISO NO.订货号 806 104	803 014	803 016	803 018	803 021	803 025

801



ISO 801 524

Head Dia(1/10mm)	018	021	030	040	050
Length(mm)	1.8	2.1	3	4	5
ISO NO.订货号 806 104	801 018	801 021	801 030	801 040	801 050

电镀HP金刚砂磨头 Electroplated HP diamonds Burs

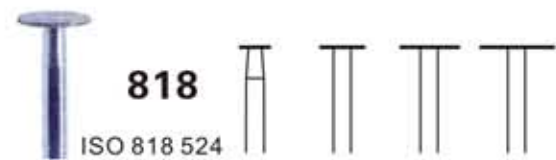

Head Dia(1/10mm)	042	061	080	100
Length(mm)	0.5	0.5	0.5	0.5
ISO NO.订货号 806 104	818 042	818 061	818 080	818 100



Head Dia(1/10mm)	060	080	100	120
Length(mm)	2.3	2.3	2.3	2.3
ISO NO.订货号 806 104	820 060	820 080	820 100	820 120



Head Dia(1/10mm)	035	045	054	065	080	100	120
Length(mm)	1	1.5	1.5	2.0	2.5	2.5	2.5
ISO NO.订货号 806 104	909 035	909 045	909 054	909 065	909 080	909 100	909 120

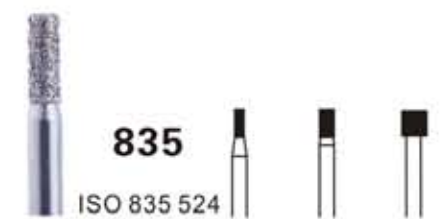

Head Dia(1/10mm)	014	021	035
Length(mm)	4	4	3.5
ISO NO.订货号 806 104	835 014	835 021	835 035



Head Dia(1/10mm)	021	025	033	045	063	097	120
Length(mm)	0.7	0.9	1	1.1	1.3	1.5	1.5
ISO NO.订货号 806 104	825 021	825 025	825 033	825 045	825 063	825 097	825 120



Head Dia(1/10mm)	025	057	073
Length(mm)	2	2	3
ISO NO.订货号 806 104	812 025	812 057	812 073

电镀HP金刚砂磨头 Electroplated HP diamonds Burs



Head Dia(1/10mm)	018	030	035	055	065	053	Head Dia(1/10mm)	020	025	033	040
Length(mm)	8	8	8	8	8	12	Length(mm)	12	10	8	8
ISO NO.订货号 806 104	837 018	837 030	837 035	837 055	837 065	837 053	ISO NO.订货号 806 104	881 020	881 025	881 033	881 040



Head Dia(1/10mm)	014	018	023	Head Dia(1/10mm)	016	018	025	031	035	040	050
Length(mm)	11.5	11.5	15	Length(mm)	8	8	10	10	10	9	9
ISO NO.订货号 806 104	859 014	859 018	859 023	ISO NO.订货号 806 104	847 016	847 018	847 025	847 031	847 035	847 040	847 050



Head Dia(1/10mm)	023	030	040	035	050	065	Head Dia(1/10mm)	014	025	031	029
Length(mm)	8	10	9	10	13	13	Length(mm)	10	15	15	15
ISO NO.订货号 806 104	850 023	850 030	850 040	85 035	850 050	850 065	ISO NO.订货号 806 104	292 014	292 025	292 031	292 029

金刚砂砂片 Flexible diamond discs

355D



Head Dia(mm) 订货号 (HP)	19	22	L = 0.45
Order NO H 355D ISO NO 806 104 355D 524			
Order NOH 355DF ISO NO 806 104 355D 514			

355



Head Dia(mm) 订货号 (HP)	19	22	L = 0.45
Order NO H 355 ISO NO 806 104 355 524			
Order NOH 355F ISO NO 806 104 355 514			

345D



Head Dia(mm) 订货号 (HP)	19	22	L = 0.45
Order NO H 345D ISO NO 806 104 345D 524			
Order NOH 345DF ISO NO 806 104 345D 514			

345

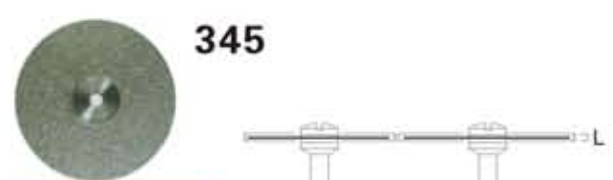

Head Dia(mm) 订货号 (HP)	19	22	L = 0.45
Order NO H 345 ISO NO 806 104 345 524			
Order NOH 345F ISO NO 806 104 345 514			

350D

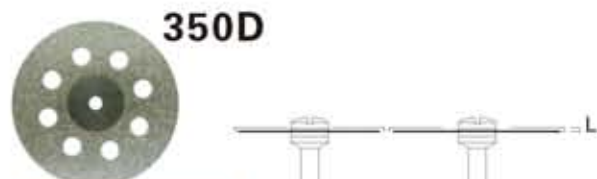

Head Dia(mm) 订货号 (HP)	19	22	L = 0.45
Order NO H 350D ISO NO 806 104 350D 524			
Order NOH 350DF ISO NO 806 104 350D 514			

350

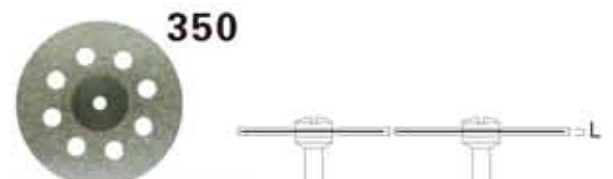

Head Dia(mm) 订货号 (HP)	19	22	L = 0.45
Order NO H 350 ISO NO 806 104 350 524			
Order NOH 350F ISO NO 806 104 350 514			

360

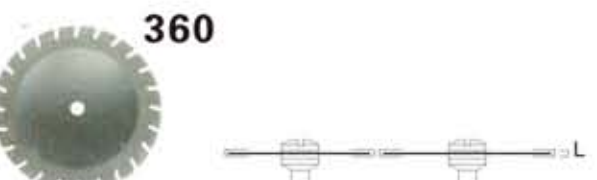

Head Dia(mm) 订货号 (HP)	19	22	L = 0.45
Order NO H 360 ISO NO 806 104 360 524			
Order NOH 360F ISO NO 806 104 360 514			

HP 烧结金刚石磨头 HP Sintered Diamond Burs

141
ISO 141 524



Head Dia(1/10mm)	025	031	050
Length(mm)	8	8	12
ISO NO.订货号 807 104	141 025	141 031	141 050

165
ISO 165 524

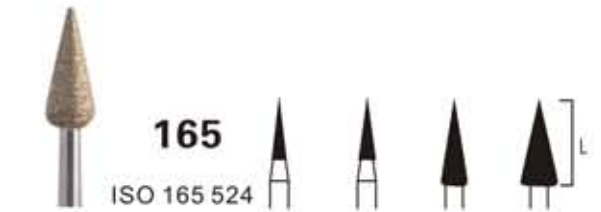

Head Dia(1/10mm)	021	023	035	050
Length(mm)	8	8	12	12
ISO NO.订货号 807 104	165 021	165 023	165 035	165 050

001
ISO 001 524

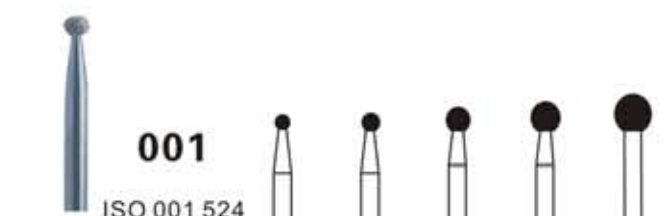

Head Dia(1/10mm)	021	025	033	040	050
Length(mm)	2.1	2.5	3.3	4	5
ISO NO.订货号 807 104	001 021	001 025	001 033	001 040	001 050

014
ISO 014 524

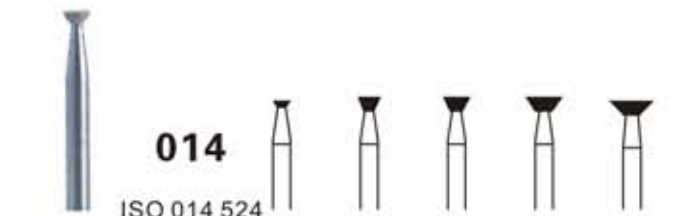

Head Dia(1/10mm)	025	031	037	050	060
Length(mm)	1	2	2	2	2
ISO NO.订货号 807 104	014 025	014 031	014 037	014 050	014 060

041
ISO 041 524



Head Dia(1/10mm)	050	060	080
Length(mm)	2	2	3
ISO NO.订货号 807 104	041 050	041 060	041 080

068
ISO 068 524



Head Dia(1/10mm)	060
Length(mm)	2
ISO NO.订货号 807 104	068 060

111
ISO 111 524

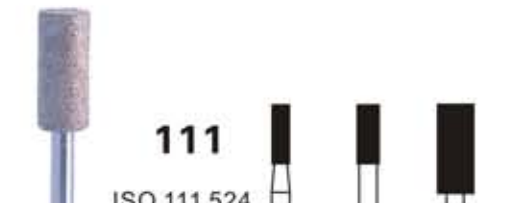

Head Dia(1/10mm)	025	031	050
Length(mm)	8	8	12
ISO NO.订货号 806 104	111 025	111 031	111 050

HP 烧结金刚石磨头 HP Sintered Diamond Burs

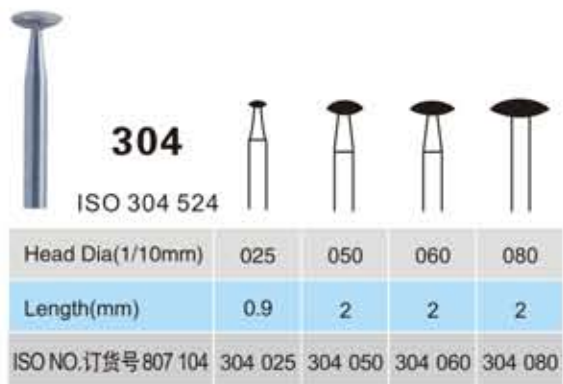
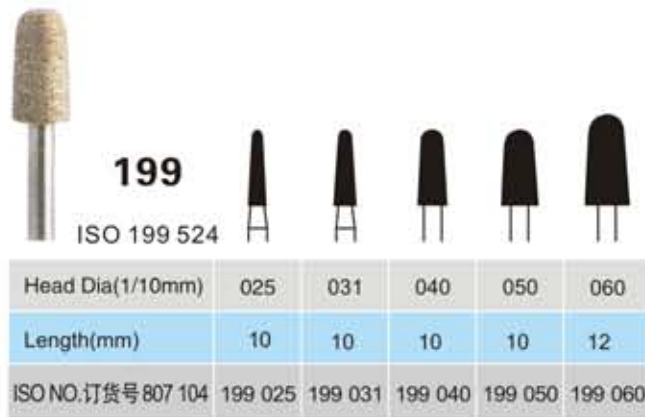
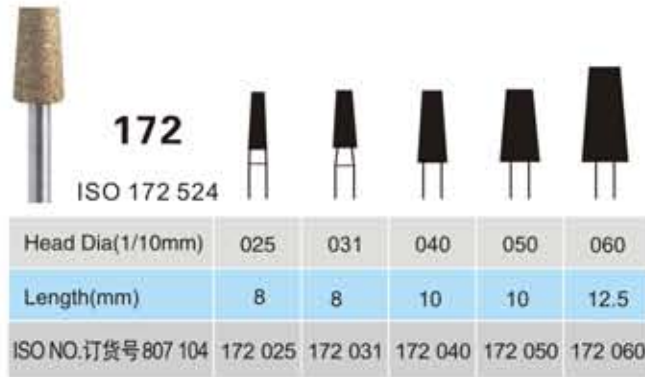

牙科门诊用硅橡胶抛光磨头 Silicon rubber polishing bur applied in Dentist Clinic

1、贵金属专用类 Special purpose for noble metal

用于对黄金、银汞合金等金属与贵金属，复合树脂工件进行成型修整加工和高度抛光。
To be used to mold, process and highly polish gold, silver-hydrargyrum alloy and compound resin workpiece.

- 粗颗粒 Coarse granule
- 中颗粒 Medium granule
- 细颗粒 Fine granule

2、陶瓷类专用 Special purpose for Ceramics

用于对陶瓷和牙釉质进行修整加工与抛光，也适用于树脂、复合树脂和银汞合金的修整抛光。
To be used to mold, process and polish ceramics and dental enamel, and also to mold and polish resin, compound resin and silver-hydrargyrum alloy.

- 粗颗粒 Coarse granule
- 中颗粒 Medium granule
- 细颗粒 Fine granule

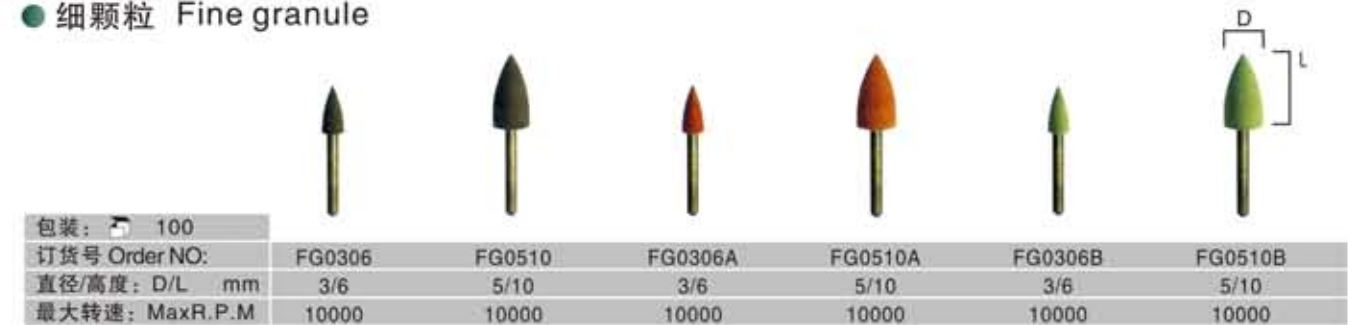

牙科门诊用硅橡胶抛光磨头 Silicon rubber polishing bur applied in Dentist Clinic



包装: 100						
订货号 Order NO:	RA0510	RA0510A	RA0510B	RA0510C	RA0510D	RA0510E
直径/高度: D/L mm	5/10	5/10	5/10	5/10	5/10	5/10
最大转速: MaxR.P.M	10000	10000	10000	10000	10000	10000



包装: 100						
订货号 Order NO:	RA1201	RA1201A	RA1201B	RA1201C	RA1201D	RA1201E
直径/高度: D/L mm	12/1	12/1	12/1	12/1	12/1	12/1
最大转速: MaxR.P.M	10000	10000	10000	10000	10000	10000



包装: 100						
订货号 Order NO:	RA1203	RA1203A	RA1203B	RA1203C	RA1203D	RA1203E
直径/高度: D/L mm	12/3	12/3	12/3	12/3	12/3	12/3
最大转速: MaxR.P.M	10000	10000	10000	10000	10000	10000



包装: 100						
订货号 Order NO:	RA0610	RA0610A	RA0610B	RA0610C	RA0610D	RA0610E
直径/高度: D/L mm	6/10	6/10	6/10	6/10	6/10	6/10
最大转速: MaxR.P.M	10000	10000	10000	10000	10000	10000

牙科技工室用硅橡胶抛光磨头 Silicon rubber polishing bur applied in Technical Worker Room

1、贵金属专用类 Special purpose for noble metal

用于黄金, 贵金属的修磨抛光。
To be used to mold and polish gold, noble metal.

- 粗颗粒 Coarse granule
- 中颗粒 Medium granule
- 细颗粒 Fine granule

2、陶瓷类专用 Special purpose for Ceramics

用于烤瓷牙的修磨和抛光。
To be used to mold and polish roase porcelain tooth.

- 粗颗粒 Coarse granule
- 中颗粒 Medium granule
- 细颗粒 Fine granule

3、树脂类专用 Special purpose for resin

用于各种复合树脂基托, 丙烯酸基托等义齿树脂材料修磨和抛光。
To be used to mold and polish compound resin base acrylic acid base etc.

- 粗颗粒 Coarse granule
- 中颗粒 Medium granule
- 细颗粒 Fine granule



包装: 100							
订货号 Order NO:(HP)	H9601	H9602	H9603	H9604	H9605	H9606	H9607
直径/高度: D/L mm	10/24	10/24	10/24	10/24	10/24	10/24	10/24
最大转速: MaxR.P.M	20000	20000	20000	20000	20000	12000	12000



包装: 50						
订货号 Order NO:(HP)	H10601	H10602	H10603	H11601	H11602	H11603
直径/高度: D/L mm	13/20	13/20	13/20	15/18	15/18	15/18
最大转速: MaxR.P.M	8000	8000	8000	8000	8000	8000

牙科技工室用硅橡胶抛光磨头
Silicon rubber polishing bur applied in Technical Worker Room



包装: 100						
订货号 Order NO:(HP)	H8601	H8602	H8603	H8604	H8605	H8606
直径/高度: D/L mm	10/21	10/21	10/21	10/21	10/21	10/21
最大转速: MaxR.P.M	20000	20000	20000	20000	20000	12000



包装: 100						
订货号 Order NO:(HP)	H8621	H8622	H8623	H8624	H8625	H8626
直径/高度: D/L mm	6/17	6/17	6/17	6/17	6/17	6/17
最大转速: MaxR.P.M	20000	20000	20000	20000	20000	12000



包装: 100						
订货号 Order NO:(HP)	H7601	H7602	H7603	H7604	H7605	H7606
直径/高度: D/L mm	10/20	10/20	10/20	10/20	10/20	10/20
最大转速: MaxR.P.M	20000	20000	20000	20000	20000	12000



包装: 100						
订货号 Order NO:(HP)	H7611	H7612	H7613	H7614	H7615	H7616
直径/高度: D/L mm	8/20	8/20	8/20	8/20	8/20	8/20
最大转速: MaxR.P.M	20000	20000	20000	20000	20000	12000

牙科技工室用硅橡胶抛光磨头
Silicon rubber polishing bur applied in Technical Worker Room



包装: 100						
订货号 Order NO:(HP)	H8631	H8632	H8633	H8634	H8635	H8636
直径/高度: D/L mm	4/13	4/13	4/13	4/13	4/13	4/13
最大转速: MaxR.P.M	20000	20000	20000	20000	20000	12000



包装: 100						
订货号 Order NO:(HP)	H7631	H7632	H7633	H7634	H7635	H7636
直径/高度: D/L mm	4/13	4/13	4/13	4/13	4/13	4/13
最大转速: MaxR.P.M	20000	20000	20000	20000	20000	12000



包装: 100						
订货号 Order NO:(HP)	H5601	H5602	H5603	H5604	H5605	H5606
直径/高度: D/L mm	12/2	12/2	12/2	12/2	12/2	12/2
最大转速: MaxR.P.M	12000	12000	12000	12000	12000	12000



















包装: 100						
订货号 Order NO:(HP)	H4601	H4602	H4603	H4604	H4605	H4606
直径/高度: D/L mm	12/3	12/3	12/3	12/3	12/3	12/3
最大转速: MaxR.P.M	12000	12000	12000	12000	12000	12000

带柄车石 MOUNTED PIONTS

GREEN MOUNTED STONES(绿车石)









绿车石(碳化硅)用于研磨烤瓷、金、银。
For finishing porcelain, composite, gold and silver alloys

100								
订货号: ORDER NO(HP)								
06040-	2	9	10	11	13	19	20	29

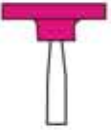
100								
订货号: ORDER NO(HP)								
06040-	33	35	36	42	44	45	52	53









PINK MOUNTED STONES (红车石)

For sharpening, grinding cobalt-chrome alloys and porcelain-to-metal
红车石(纯氧化铝)用于研磨贵金属及半贵金属

100								
订货号: ORDER NO(HP)								
06050-	9	10	11	13	20	42	43	50









WHITE MOUNTED STONES (白车石)

For sharpening, grinding porcelain-to-metal alloys and semi-precious.
白车石(纯氧化铝)用于研磨非贵金属、烤瓷钢。

100								
订货号: ORDER NO(HP)								
06070-	9	10	11	13	20	28	50	65

BLUE MOUNTED STONES (蓝车石)

For use on cobalt-chrome and non-precious alloys
蓝车石(纯氧化铝)用于研磨钢托及非贵金属。

100								
订货号: ORDER NO(HP)								
06080-	10	13	20	35	42	41	43	50

RISING 锐鑫
HANZHONG RUIXIN TOOLS

速度 · 钢性 · 耐磨
HANZHONG RUIXIN TOOLS
锐鑫刃具

扫一扫,获取更多详情
Flicking a for more details



官方网站 Official Website



官方微信 Official Micro Letter